

THIS PACKAGE CONTAINS



A(20)

B(4)

C(4)

D(4)

E(4)

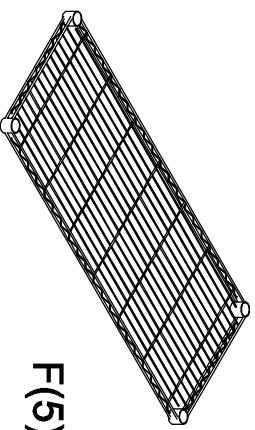

F(5)

Step 1

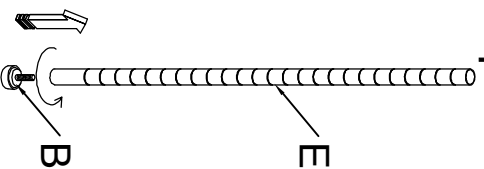

Step 2

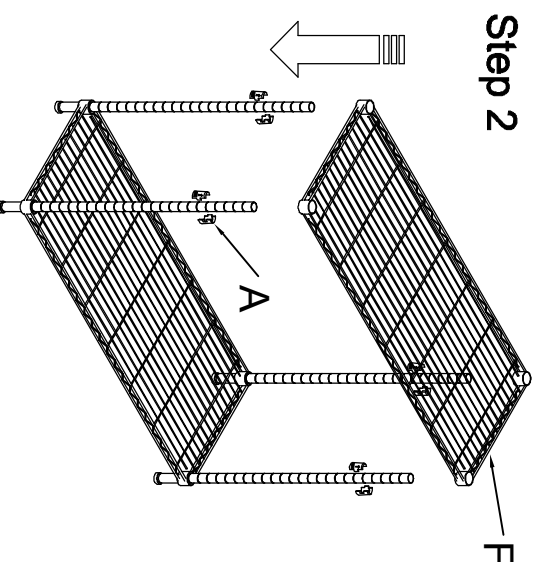

Step 4

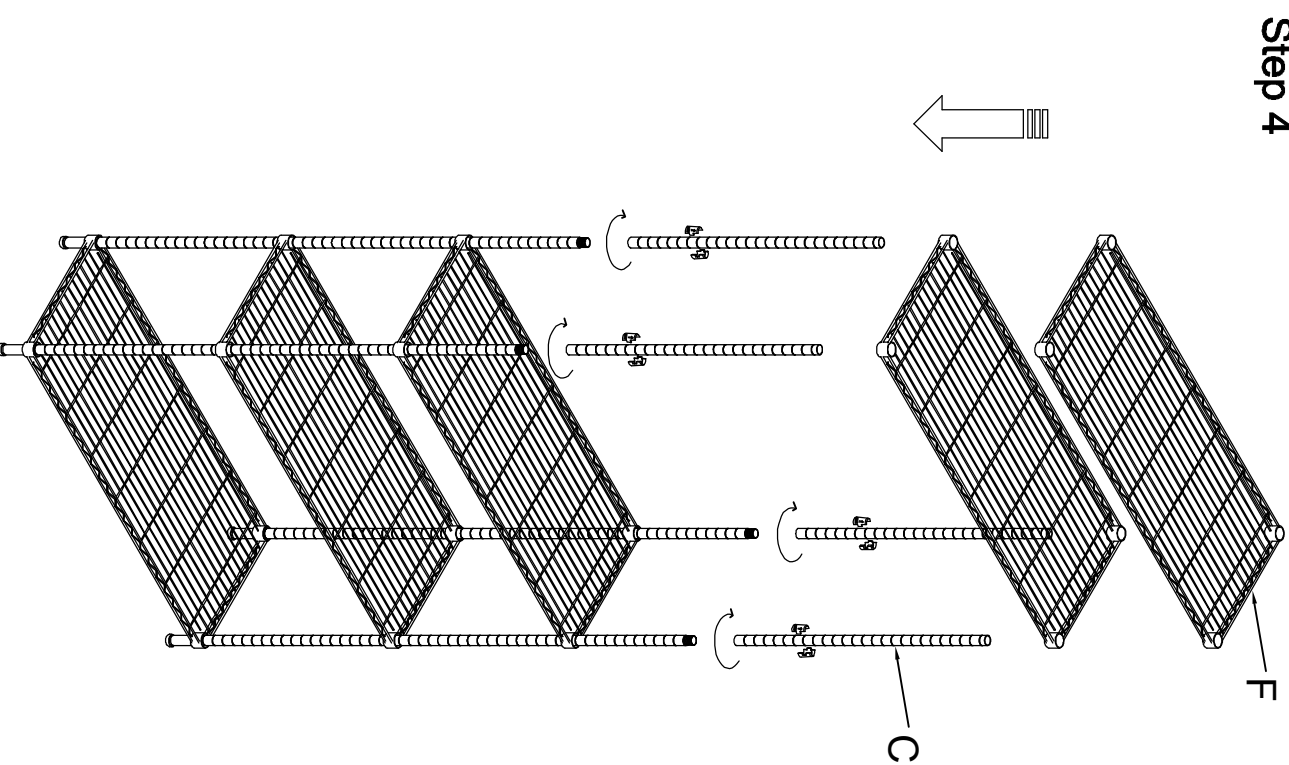

Step 3

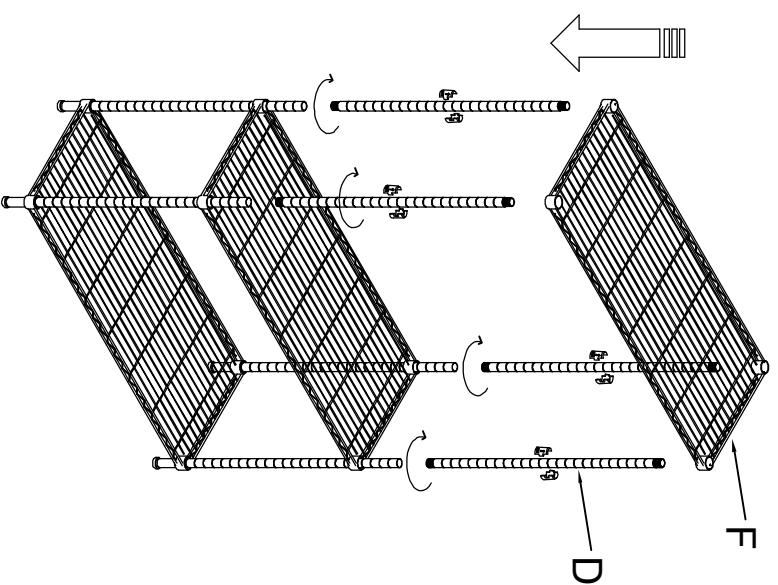

1

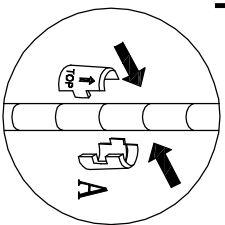

Locate the ridge into any of the grooves at the desired height

2

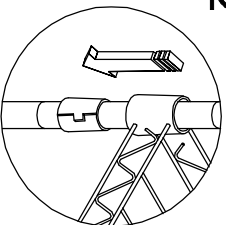

Locate the shelf down over the plastic sleeve

3

